

## Effect of PLTS power factor settings on power losses and voltage conditions in 20 kV medium voltage networks

Resti Savira\* and Budi Sudiarto

Department of Electrical Engineering, Faculty of Engineering, Universitas Indonesia, **Indonesia**

\*Corresponding Author: [restisavira19@gmail.com](mailto:restisavira19@gmail.com)

Received 20<sup>th</sup> April 2023; 1<sup>st</sup> Revised 8<sup>th</sup> May 2023; 2<sup>nd</sup> Revised 22<sup>nd</sup> May 2023; Accepted 28<sup>th</sup> May 2023

 Cite this <https://doi.org/10.24036/jptk.v6i2.32523>

**Abstract:** As technology develops, the rapid increase in PV capacity will affect the grid. This makes it important to determine the PV limit that can be injected into the grid defined as the PV Hosting Capacity (PVHC). In this paper, the author evaluates and analyses the impact of PV connections on medium voltage distribution lines (20kv) using ETAP 19.01 simulation. A medium voltage Grid with a capacity of 30MVA, has an industrial load varies from 650 kVA to 25 kVA with the total load capacity of 2225 KVA. The loads are supplied from two sources, grid and PV system. The simulation results state that the best of grid performance which provide the best losses and voltage condition when connecting 100% capacity of PV to the existing grid network is by setting the inverter power factor to 0.9. This setting will provide lowest power losses of 0,7 kW and improve the voltage value.

**Keywords:** PLTS Roof; Power factor; Losses; Voltage magnitude

### 1. Introduction

Open pit mining is one of the mining methods, where mining activities are influenced by climate and mine water Rooftop PV utilization dominates both residential, commercial, and industrial sectors. Since the launch of the ESDM Ministerial Regulation governing the utilization of the Rooftop PLTS system in December 2018, Indonesia's PLN (State Electricity Company) customers installed to date have reached 2,566 with a total installed capacity of 18.19 MWp. The industrial sector is the largest contributor with a capacity of 7,757 MWp from 16 customers, followed by the household sector with a capacity of 5,151 MWp from a total of 2,151 customers, and the business sector with a capacity of 1,910 MWp with a total of 190 customers. The last three sequences contributed to the capacity of PLTS Roof in the social sector, Government, and special services. Industrial loads are generally connected to the medium voltage network. Utilizing PV systems in the provision of electricity needs can help reduce the cost of electricity bills. On the other hand, products manufactured using Green Energy technology have more value in the international market. Carbon credit owned by an industry that uses Green Energy technology is also very beneficial from the user (industry) side.

As technology develops, current PV systems not only operate Off-Grid but also On-Grid. An off-Grid PV system is a stand-alone system PV power plant. While On-grid, connected to the utility power grid. Connecting the PV system to the power distribution network level will change the characteristics of the distribution network (Koutroumpezis & Safigianni, 2010). PV systems are becoming a widely used choice because of several advantages, including the most cost-effective choice, widespread availability of raw materials (solar panels), low repair, pollution-free, longevity, and abundance. However, the integration of the DG system into the main grid can also cause several problems such as voltage regulation, frequency and power variation, power quality, reliability, stability and protection issues, safety, synchronization, grid operation economics, efficiency, and lower cost (Kumar, 2020). The higher power supplied by the inverter, the higher disturbance generated in the system (Gusdhi & Sudiarto, 2020). A rapid increase in PV capacity will cause negative effects on the grid, such as overvoltage, and potential reserve power flow (which can damage/affect the operation of the protection system) from line congestion which leads to additional heat in the conductors and cables. This makes it important to determine the limit of PV that can

be injected into the grid, without forcing the operating performance indicators in extreme failure conditions ([Esau et al., 2023](#)). The limit of PV systems that can be integrated into the electricity network can be defined as the PV Hosting Capacity (PVHC). PVHC plays an important role in establishing the characteristics of network problems that arise as a result of connection and can also determine the mitigation of prevention against violations of abnormal conditions in the network due to the integration of the PV system ([Kazemi-Robati et al., 2022](#)).

Most utilities accept 15% PV penetration as a ratio of the PV capacity that can be injected into the utility grid ([Ding et al., 2016](#)). Based on the regulations of the Indonesian National Electricity Company (PLN), the PV penetration rate that can be connected to the 20KV national electricity distribution network is 25% of the peak load, where this research looks at the network frequency response which does not cross the Indonesian grid code limit of 50Hz ([Darussalam & Garniwa, 2018](#)). Several studies confirm that 10%-50% of Distributed Generator (DG) penetration can be safely absorbed by the electricity network. Therefore, it is reasonable to assume that adequate DG integration into the utility grid at a suitable location can improve the voltage profile and voltage stability along with reducing active and reactive power losses ([Juanuwattanakul & Masoum, 2012](#)). Research ([Ul Abideen et al., 2020](#)), determines PVHC by assuming the generation of PV systems iteratively increases from normal conditions 74% of the total maximum load capacity, increased gradually to 100% of normal load consumption. It was found that the penetration rate at residential loads was between 82% and 150%, industrial 31%, while commercial ones were limited by available roof space.

On the other hand, many studies have focused on the Power Quality produced by PV Inverters and the stability of the network (Grid). Most studies evaluating the impact of PV penetration into the grid are on Voltage Magnitude and Reserve Power flow. However, several studies have also evaluated the impact of not interfering with the actual grid function. Connecting small-scale PV systems to the grid network considers changes in the profile of the load curve, the harmonic component of the current waveform, and the variation in consumer power factor (PF) calculated by the grid operator. The grid operator finds that the interaction between the PV Generator and the load can cause the PF to be low on the Grid side. Even when the PV system and load operate separately within acceptable limits ([de Parijós Junior et al., 2023](#)). The research was carried out by simulating PV generation connected to a grid network, with 80% loading of the transformer capacity, where each node has the same value, a load power factor of 0.95, and a constant load. It is known that as the distance of PV DG from the secondary side of the transformer increases, the reactive power compensation required also increases ([Arshad & Lehtonen, 2018](#)). In ([Ding et al., 2016](#)), the author found that the power factor of the PV inverter affects the PVHC well, and the setting in volts/var plays an important role in improving the voltage profile. In ([Hung et al., 2013](#)), the author focuses on testing the location and size of the PVDG where the optimal power factor of the individual DG units is an important part of minimizing power losses which are always neglected. The author in ([Esmaili et al., 2014](#)), proved that the DG problem can influence the status of network voltage and network losses. Where power losses are an important part of the distribution system and must be kept low and controlled. In ([Fatima, Püvi, Arshad, et al., 2021](#)), the author conducted research on the impact of the number of PV integration on network losses. Power flow analysis is an important step in calculating losses. Network losses will initially start to decrease from their original value, until the PV penetration rate results in minimal losses, losses will increase again when further PV power is exceeded. The trend of increasing losses forms a U-shaped curve.

Based on the literature above, it is very important to analyse the PVDG connection to the distribution network. In low-voltage networks, voltage rise is the most important factor limiting PVHC ([Fatima, Püvi, & Lehtonen, 2021](#)). The author in ([Torquato et al., 2018](#)) argues that things that affect PVHC on LV include the number of subscribers, the length of the LV network, connection scenarios, and the load distribution of each type of customer. Reactive power is of little consequence as a result of PV integration in the LV network. However, connection to medium voltage networks needs to be considered ([Bollen & Rönnberg, 2017](#)). Therefore, in this paper, the author analyses the impact of PVDG connection on medium voltage distribution lines. The entire paper consisting of section I is an introduction. Section II The research method contains the research flow. Section III Result is the result of the research. Section IV Discussion contains a discussion of research results. Section V, conclusions from research results. Finally, section VI, paper reference.

## 2. Methods

This paper evaluates the impact of integrated PV systems on the 20kv medium grid voltage grid. The impact evaluation was carried out through the ETAP 19.01 simulation. A medium voltage network system from the Grid with a capacity of 30MVA connected to a 150KV-20KV step-down transformer with a capacity of 6MVA. This system supplies medium voltage network loads. Assuming the Lump Load is an industrial load, where the Lump Load is a type of load with a combination of static load and motor equipment. The load capacity varies with a total of 2225 KVA, with a spread ranging from 650 KVA, 365 KVA, 440 KVA, 175 KVA, 195 KVA, 175 KVA, 200 KVA, and 25 KVA. Each load is supplied from two sources of electricity, namely electricity from the Grid and the PV system. This paper is intended to determine the penetration impact of PV systems that are connected parallel to the utility medium voltage network, from the perspective of the grid and the owner of the PV system. The stages of the research are attached as follows:

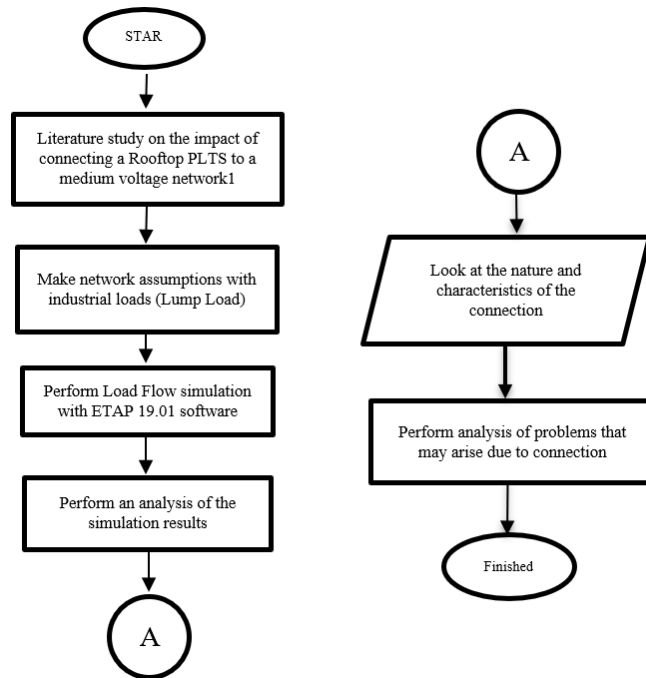

Figure 1. Research flowchart

### Single line diagrams

The medium voltage electrical network is assumed to be the following network model (Fig. 2).

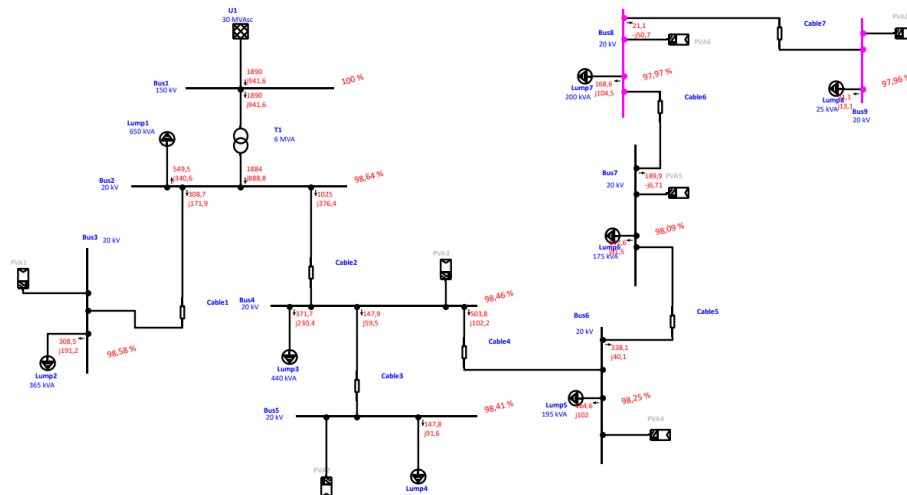

Figure 2. Single line diagram



The network model is used based on (Bajagain et al., 2020), where the PV connection occurs at each load point. It is assumed that each load is supplied using two sources of electricity, namely utilities and PLTS Roof, with a total network length of 4km.

**Industrial loads**

It is assumed that industrial loads in the simulation use Lump Loads. A lump Load is a type of power system load that contains a lot of electric motors. This load is assumed to be applied to a feeder which has a combined motor load and static load. Lump Load has basic specifications for voltage level and power capacity complete with power factor. The load power factor is determined at the beginning with a lagging value of 0.85. Distribution starts from 650 KVA, 365 KVA, 440 KVA, 175 KVA, 195 KVA, 175 KVA, 200 KVA, and 25 KVA.

**PV penetration**

PV penetration is assumed to be the percentage rate of PV that is parallel to the utility grid. The penetration rate starts from 15%, 20%, 25%, 30%, 35%, 40%, 45%, 50%, and 100% of the total installed load capacity. PLTS Roof is installed at each load connection point on the network. There are seven points connecting the PLTS Roof parallel to the utility grid at seven load points.

Table 1. Equipment specifications

Equipment	Information
Utility grid	Swing, 30 MVA
Transformer	6 MVA, 150kV / 20kV
Bus	20kV
Lump Load	650kVA, 365 kVA, 440kVA, 175kVA, 195kVA, 175kVA, 200kVA, 25kVA
PV Penetration	15%, 20%, 25%, 30%, 35%, 40%, 45%, 50%, 100%
Network length	4 km
Cable	50Hz, XLPE 100% 33kV 3/C CU 35mm <sup>2</sup>

**3. Results**

**Scenario I**

In the experiment, I, the electrical network from the SLD above was tested with a power flow simulation at ETAP 19.01. Scenario I, where the entire load is supplied purely from the 30MVA utility Grid without penetration of the Roof PLTS. The simulation results show that there is a drop in voltage on buses 8 and 9 so the status of buses 8 and 9 is Undervoltage. Network losses are 10.4 kW, system PF is 0.89, and the system voltage drop percentage is 1.36 p.u.

**Scenario II**

Experiment II is an experimental scenario where the network simulation is carried out by parallelizing the PLTS Roof from each load connection point. 100% Roof PLTS inverter Power Factor, as a unity factor. With rooftop PLTS penetration ranging from 15%, 20%, 25%, 30%, 35%, 40%, 45%, 50%, and 100% of the total installed load capacity.

Table 2. PF PV 100%, PF load dan grid 0,85

PV Penetration	% PF's System	%Voltage Drop	Losses (kW)	%PF's Load
15%	87, 48	1,32 (T1)	8,3	89,67
20%	86,58	1,31 (T1)	7,6	89,72
25%	85,53	1,29 (T1)	6,9	89,78
30%	84,40	1,28 (T1)	6,2	89,83
35%	83,23	1,27 (T1)	5,7	89,87
40%	82,04	1,26 (T1)	5,2	89,91
45%	80,40	1,25 (T1)	4,7	89,96
50%	78,78	1,24 (T1)	4,3	90,00
100%	42,84	1,12 (T1)	1,8	90,28

**Scenario III**

Experiment III is an experimental scenario where the network simulation is carried out by parallelizing the PLTS Roof from each load connection point. The Power Factor of the Roof PLTS inverter is 90%, and 10% reactive power injection. With rooftop PLTS penetration ranging from 15%, 20%, 25%, 30%, 35%, 40%, 45%, 50%, and 100% of the total installed load capacity.

Table 3. PF PV 90%, PF load and grid 0.85

PV Penetration	%PF's System	%Voltage Drop	Losses (kW)	%PF's Load
15%	89,67	1,21	8,0	89,70
20%	89,73	1,16	7,3	89,77
25%	89,79	1,11	6,6	89,83
30%	89,86	1,06	5,9	89,89
35%	89,93	1,01	5,3	89,94
40%	89,99	0,96	4,7	90,00
45%	90,07	0,91	4,2	90,05
50%	90,15	0,86	3,7	90,10
100%	91,52	0,37	0,7	90,47

**Scenario IV**

Experiment IV is an experimental scenario where the network simulation is carried out by parallelizing the PLTS Roof from each load connection point. The Power Factor of the Roof PLTS inverter is 80%, and 20% reactive power injection. With rooftop PLTS penetration ranging from 15%, 20%, 25%, 30%, 35%, 40%, 45%, 50%, and 100% of the total installed load capacity.

**4. Discussion**

**Power factor**

Reactive power plays an important role in sustaining the voltage, and the PV hosting capacity can be affected by changing the power factor of the PV inverter. The smaller the value of the power factor (leading), the more reactive power will be generated from the PV inverter to the feeder, so the hosting capacity should not be reduced. Unlike the unity constant power factor, the volt/var control automatically adjusts the relative power output of the PV inverter based on the voltage (Ding et al., 2016).

In all research scenarios, it is determined that the load and the grid have a lagging power factor of 0.85. In scenario I, where the load is fully supplied from the electricity grid, a power flow simulation is carried out, and there is an Undervoltage situation on buses 8 and 9. With a system, a power factor percentage of 89.51% and a total power factor of the entire load is 89.51%. Scenario II, inverter power factor 100%, or as a unity factor.

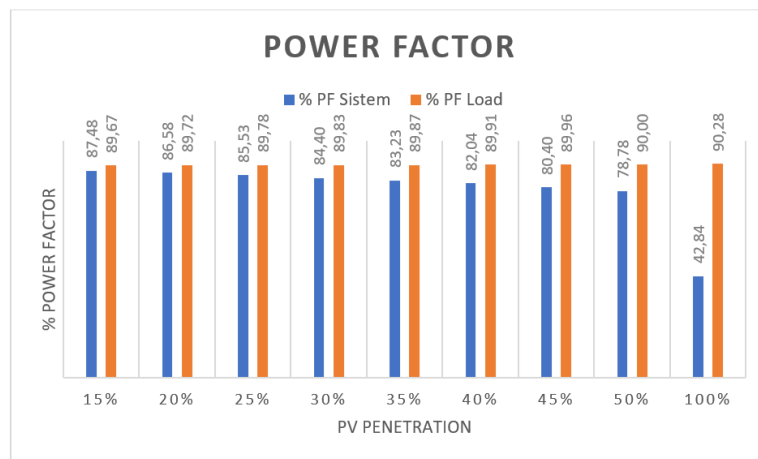

Figure 3. 100% Inverter power factor

In scenario III, the inverter power factor is determined as 90% active power and 10% reactive power.

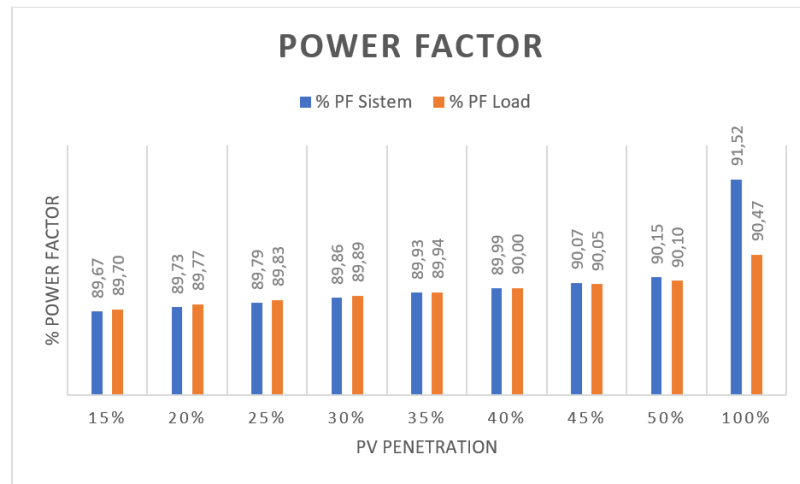

Figure 4. 90% Inverter power factor

In scenario IV, the inverter power factor is determined as 80% active power and 20% reactive power.

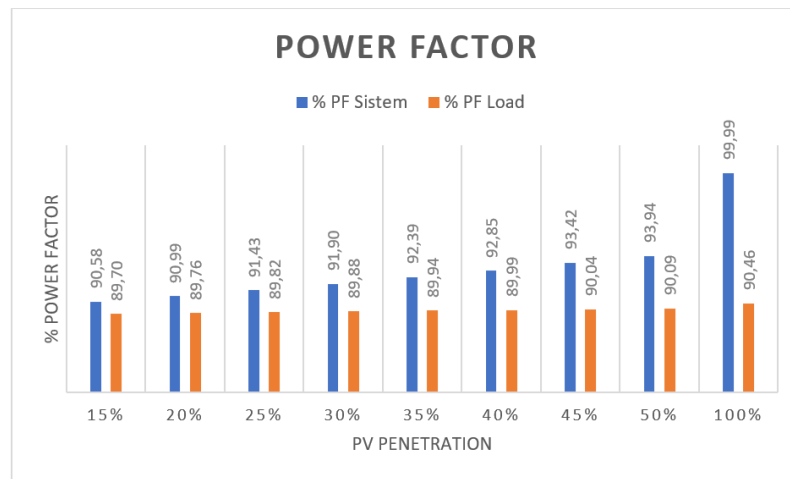

Figure 5. 80% Inverter power factor

As the PV system produces active power to feed the load, it causes less active power demand from the grid, directly impacting the power factor on the grid side. In (de Parijós Junior et al., 2023), the results of the study show that, when the PV system power is close to or equal to the active power required by the load, the calculated power factor on the grid side will be close to zero.

The results of this study can be seen in Figure 3. Graph of the power factor where the power factor of the PV inverter system is set at 100% as the unity factor. The results show that the greater the penetration value of a Rooftop PLTS that is integrated with the grid will affect the grid side power factor. Solar Rooftop penetration of 100% of the installed load capacity makes the power factor on the grid side worth 42.84%. Where this value is the power factor value which is not permitted in the electrical connection regulations. In the scenario I, the permissible PV penetration rate integrated with the grid is limited to 25% with a power factor of 85.53%. In scenario III, the inverter power factor is determined to be 90%. In this scenario, the total penetration of integrated PV to the grid increases to 100%, with a good power factor of 91.52% on the grid side. The same is the case with scenario IV, where the inverter power factor is determined as 80%. The amount of PV penetration that can be integrated with the grid also reaches 100% with a calculated power factor on the grid side of 99.99%. So, in this case, the power factor can be

said to have an influence on the amount of PV penetration that can be integrated into the grid network. In this case, the PV inverter power factor can be set at 80% and 90% levels to keep the grid side power factor within safe limits, not violating electrical safety and security regulations.

**Losses**

Reactive power control is used to optimize system loss reduction. Reactive power regulation is also known as a volt/ var control strategy in distribution systems (Liu et al., 2015). In this study, it was found that the power factor setting on the PV inverter affects the overall system losses. Among the four scenarios above, the lowest losses are obtained at a PV inverter power factor of 90%. This is related to the theory that, the more power flows, the greater the current flowing in the network (1).

$$P = I^2 \cdot R \tag{1}$$

$$S_{node} = (P_{load} - P_{pv}) + j (Q_{load} - Q_{pv}) \tag{2}$$

$$\text{Nodal Current} = (S_{node}) / (V_{node}) \tag{3}$$

Where,

P = conductivity loss (W)

R = total conductor resistance ( $\Omega$ )

I = average load current (A)

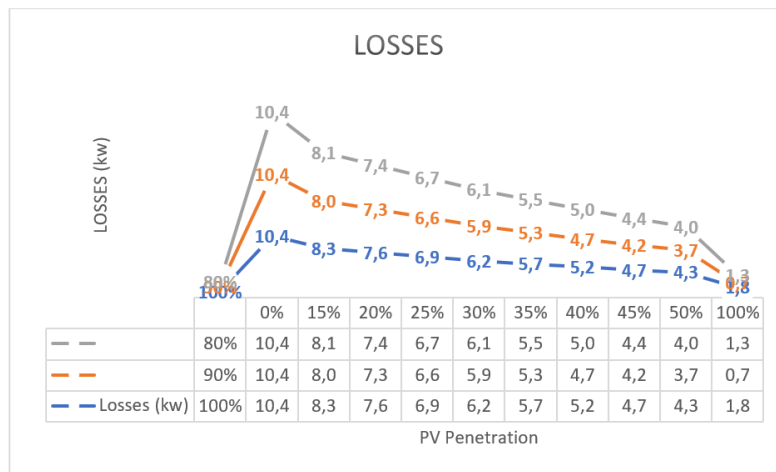

Figure 6. System Losses for different Power Factor

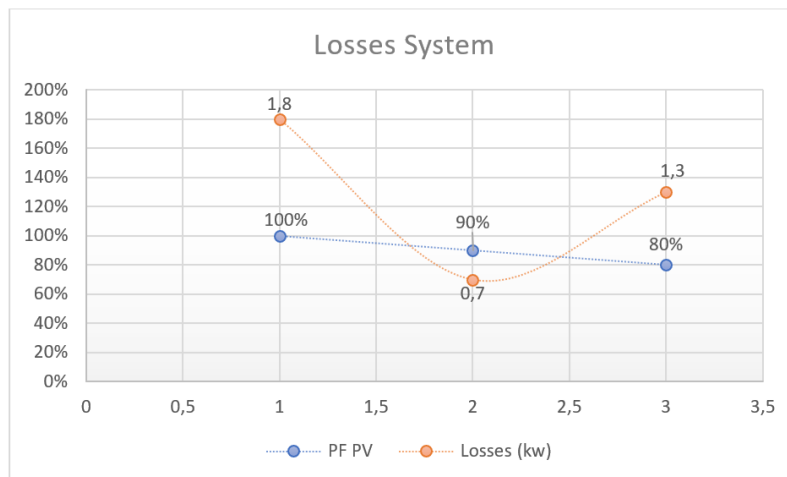

Figure 7. U-Shape Power Factor's Curve

In (Soleh & Taryo, n.d.) and (Fatima, Püvi, Arshad, et al., 2021), in equations (1), (2), and (3). It is said



that network losses generally result in cable resistance and can be reduced by a certain amount of PV penetration by supplying the load locally. However, a higher level of PV integration can interrupt system balance during reverse power flow, thereby increasing system losses. According to the results of the author's research, the effect of adding reactive power with a greater percentage causes an increase in system losses.

When the PV inverter power factor is 100% (unity factor), system losses are 1.8. And when the PV inverter power factor is 90%, the system losses become 0.7. There is a reduction in the value of losses with changes in the power factor above. However, when the PV inverter power factor was lowered to 80%, the system losses again increased to 1.3. So that the Losses curve forms a U-Shape curve. Based on these results, it can be said that PV penetration that can be integrated into the grid network reaches 100% with low system losses, namely with the inverter power factor set at 90%.

### Voltage magnitude

Both active and reactive power is controlled to stay within the safe limit of magnitude voltage. It was found that the reactive power control method can effectively mitigate system voltage magnitude fluctuations (Liu et al., 2015). In the simulation without a PV system on the network, it can be seen in Figure 1 that the load is only supplied purely from the grid. There is an Undervoltage condition at the end of the feeder, on buses 8 and 9, and the system voltage drop percentage is 1.36 p.u, indicating a weak network.

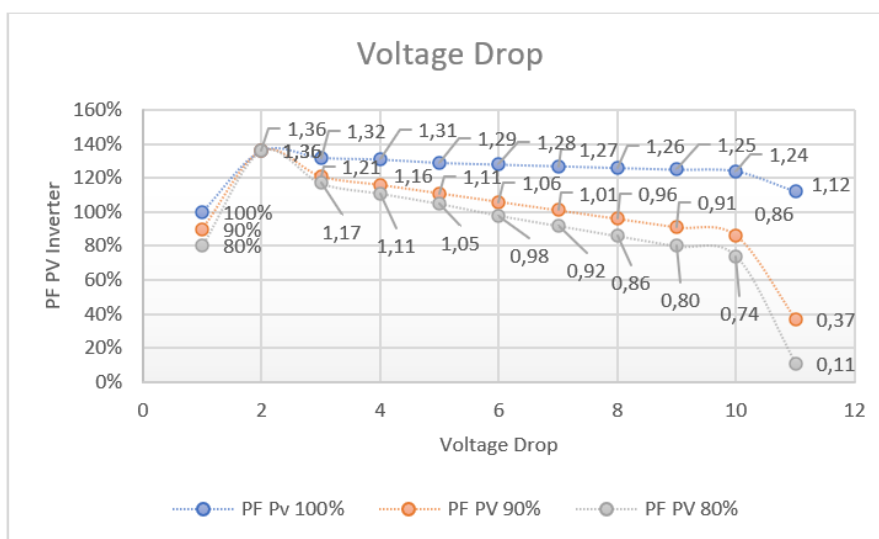

Figure 8. Voltage Drop for different Power Factor

Simulations were carried out for each scenario, with the addition of a PV system. The addition of a PV system with a hosting capacity level of 15%-100% (scenario I), and an inverter power factor of 100%, as shown in Figure 8, the greater the PV penetration, the smaller the percentage of system voltage drop. Likewise, scenario II 90%, and scenario III 80%, where each has a system voltage drop percentage of 0.37p.u and 0.11p.u. It is proven that the addition of PV can improve the voltage at the end of the feeder so that voltage failure conditions are no longer found in the network. If the penetration of the PV system does not exceed 100% hosting capacity, there is no indication of reverse power flow, which can cause an increase in voltage at each connection point.

## 5. Conclusion

From the simulation, we can see that the best performance to connect 100% of the industrial load PLTS Roof to the existing grid network is by setting the inverter power factor to 90%. This refers to the volt/var method, where the PV inverter will participate in supplying the reactive power needed by the load. As it is known that industrial loads require active and reactive loads. If the PV inverter is set at 100% (unity factor), the PV will supply an entire load of active power, so that the demand for active power from the grid is reduced. On the other hand, the reactive power required by the load will be absorbed or supplied from the grid. This causes a decrease in the power factor on the grid side to close to zero and



worsens the condition of the system.

Reducing the PV inverter power factor value will cause an increase in the value of network losses. As well as the simulation of an 80% PV inverter, resulting in higher system losses compared to 90%. Therefore, it can be said that the PV inverter power factor and system losses are closely related to determining the performance of the electrical network system. The difference is with the magnitude voltage percentage, that the greater the PV penetration in a network, the better the magnitude voltage in the system. However, this will only happen if the PV penetration does not exceed the hosting capacity limit, in this study, namely 100%.

Following are the results of the author's research regarding the analysis of the effect of connecting a Roof PLTS to a 20KV medium voltage network. The limitation of this study is that the PLTS Roof is connected at each load connection point, in the sense that the PV system is distributed not centralized. It is hoped that the research results can serve as a guideline for utilities and PV system designers in building the needs of Rooftop PV in order to maintain the security and reliability of the electrical network system. And it can be developed with research on connection analysis with large-scale centralized PLTS.

## References

- Arshad, A., & Lehtonen, M. (2018). Instantaneous Active/Reactive Power Control Strategy for Flicker Mitigation Under High PV Penetration. *IEEE PES Innovative Smart Grid Technologies Conference Europe (ISGT-Europe)*.
- Bajagain, R., Bhattarai, N., & Subedi, T. R. (2020). Impact of Grid interconnected micro-hydro based mini-grid system on Local Distribution Grid: A Case study of Taplejung mini-grid, Nepal. *International Journal of Engineering and Applied Sciences (IJEAS)*, 7(4). <https://doi.org/10.31873/ijeas.7.04.09>
- Bollen, M. H. J., & Rönnberg, S. K. (2017). Hosting capacity of the power grid for renewable electricity production and new large consumption equipment. *Energies*, 10(9). <https://doi.org/10.3390/en10091325>
- Darussalam, R., & Garniwa, I. (2018). The Effect of Photovoltaic Penetration on Frequency Response of Distribution System. *International Conference on Sustainable Energy Engineering and Application (ICSEEA)*, 81–85.
- de Parijós Junior, I. R., Galhardo, M. A. B., Costa, T. O., Pinho, J. T., Williamson, S., & Macêdo, W. N. (2023). Influence of photovoltaic microgeneration on the demand profile and its effects on the grid power quality. *Electric Power Systems Research*, 214. <https://doi.org/10.1016/j.epsr.2022.108935>
- Ding, F., Mather, B., & Gotseff, P. (2016). Technologies to Increase PV Hosting Capacity in Distribution Feeders. *IEEE Power and Energy Society General Meeting (PESGM)*, 1–5.
- Esau, Z., Ryoichi, H., & Hiroyuki, K. (2023). A flexible stochastic PV hosting capacity framework considering network over-voltage tolerance. *Energy Reports*, 9, 529–538. <https://doi.org/10.1016/j.egy.2022.11.101>
- Esmaili, M., Firozjaee, E. C., & Shayanfar, H. A. (2014). Optimal placement of distributed generations considering voltage stability and power losses with observing voltage-related constraints. *Applied Energy*, 113, 1252–1260. <https://doi.org/10.1016/j.apenergy.2013.09.004>
- Fatima, S., Püvi, V., Arshad, A., Pourakbari-Kasmaei, M., & Lehtonen, M. (2021). Comparison of economical and technical photovoltaic hosting capacity limits in distribution networks. *Energies*, 14(9). <https://doi.org/10.3390/en14092405>
- Fatima, S., Püvi, V., & Lehtonen, M. (2021). Comparison of Different References When Assessing PV HC in Distribution Networks. *Clean Technologies*, 3(1), 123–137. <https://doi.org/10.3390/cleantechnol3010008>
- Gusdhi, R. R., & Sudiarto, B. (2020). An analysis on the impacts of load types, load capacities installed and power generated by the inverter towards disturbance on an on-grid solar power plant. *IOP Conference Series: Earth and Environmental Science*, 599(1). <https://doi.org/10.1088/1755-1315/599/1/012082>

- Hung, D. Q., Mithulananthan, N., & Bansal, R. C. (2013). Analytical strategies for renewable distributed generation integration considering energy loss minimization. *Applied Energy*, 105, 75–85. <https://doi.org/10.1016/j.apenergy.2012.12.023>
- Juanuwattanakul, P., & Masoum, M. A. S. (2012). Increasing distributed generation penetration in multiphase distribution networks considering grid losses, maximum loading factor and bus voltage limits. *IET Generation, Transmission and Distribution*, 6(12), 1262–1271. <https://doi.org/10.1049/iet-gtd.2011.0841>
- Kazemi-Robati, E., Sepasian, M. S., Hafezi, H., & Arasteh, H. (2022). PV-hosting-capacity enhancement and power-quality improvement through multiobjective reconfiguration of harmonic-polluted distribution systems. *International Journal of Electrical Power and Energy Systems*, 140. <https://doi.org/10.1016/j.ijepes.2022.107972>
- Koutroumpezis, G. N., & Safigianni, A. S. (2010). Optimum allocation of the maximum possible distributed generation penetration in a distribution network. *Electric Power Systems Research*, 80(12), 1421–1427. <https://doi.org/10.1016/j.epsr.2010.06.005>
- Kumar, M. (2020). Technical Issues and Performance Analysis for Grid Connected PV System and Present Solar Power Scenario. *International Conference on Electrical and Electronics Engineering*, 639–644.
- Liu, X., Cramer, A. M., & Liao, Y. (2015). Reactive power control methods for photovoltaic inverters to mitigate short-term voltage magnitude fluctuations. *Electric Power Systems Research*, 127, 213–220. <https://doi.org/10.1016/j.epsr.2015.06.003>
- Soleh, M., & Taryo, ). (n.d.). *ANALISIS LOSSES JARINGAN DAN ALTERNATIF PERBAIKAN PADA PENYULANG JATIWANGI RAYON MAJALENGKA*.
- Torquato, R., Salles, D., Pereira, C. O., Meira, P. C. M., & Freitas, W. (2018). A Comprehensive Assessment of PV Hosting Capacity on Low-Voltage Distribution Systems. *IEEE Transactions on Power Delivery*, 33(2), 1002–1012. <https://doi.org/10.1109/TPWRD.2018.2798707>
- Ul Abideen, M. Z., Ellabban, O., & Al-Fagih, L. (2020). A review of the tools and methods for distribution networks' hosting capacity calculation. In *Energies* (Vol. 13, Issue 11). MDPI AG. <https://doi.org/10.3390/en13112758>